

Profiles

Double Roundover

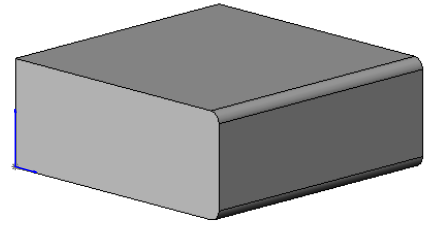

Ogee

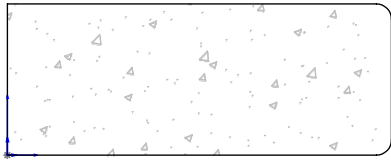
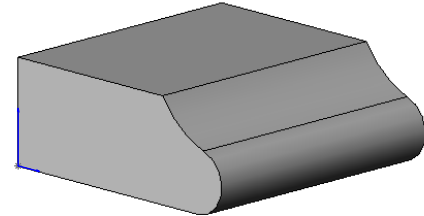
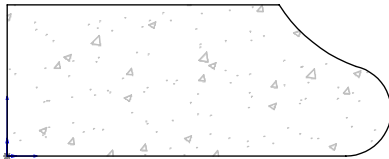

3/8" Roundover

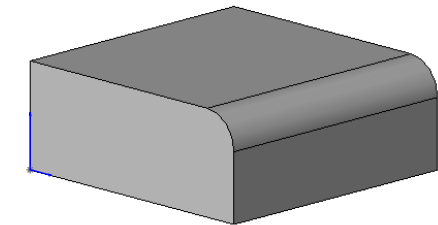
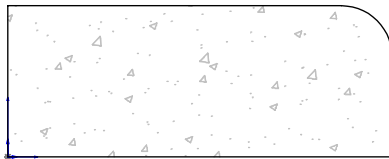

Bevel

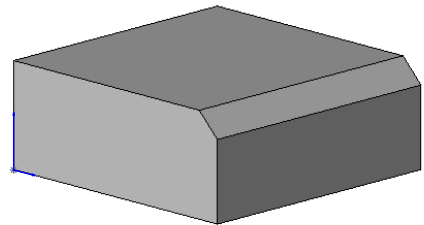
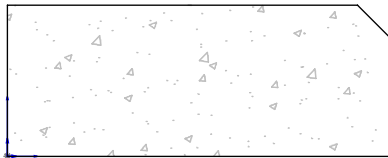

Pencil

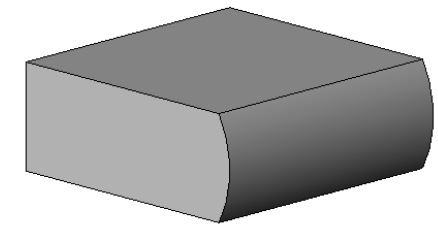
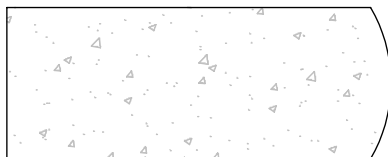

Bullnose

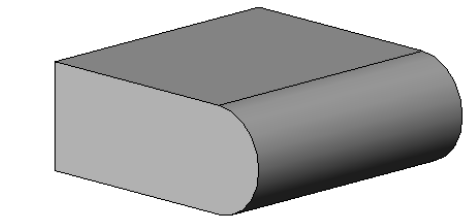
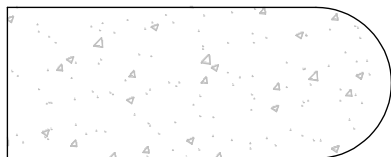

Chiseled*

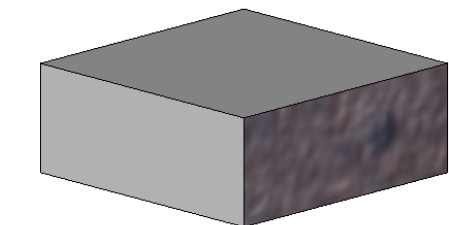
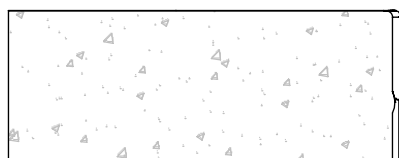

* = Upgraded Edge

Custom Profiles

6cm Ogee Bullnose

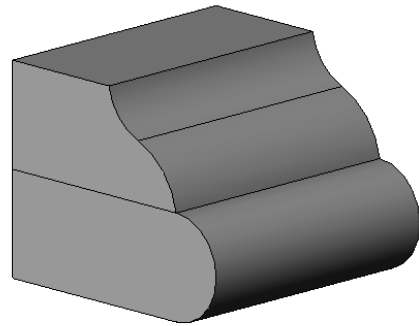
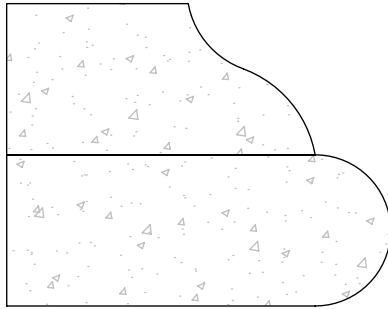

6cm Bullnose

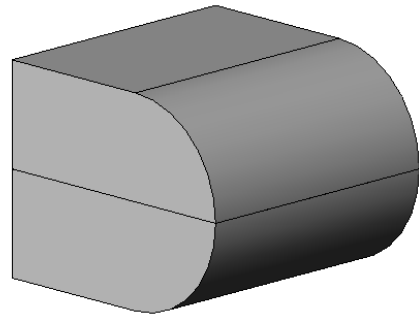
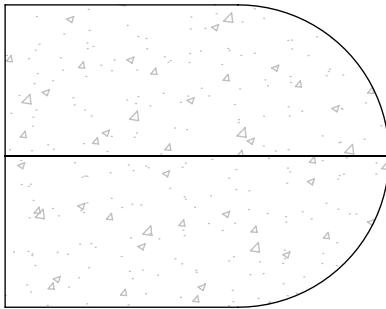

6cm Eased

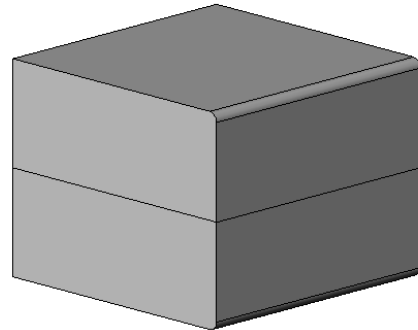
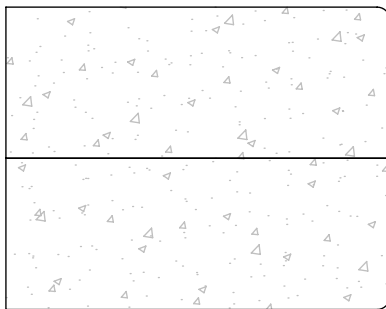

6cm Double Ogee

